



PART NUMBER: DZ 4617

****INSPECT YOUR PRODUCT FOR DAMAGE & MISSING PARTS BEFORE PROCEEDING TO INSTALLATION****

PROCEDURE FOR RETURNS OR MISSING HARDWARE

- CONTACT THE ORIGINAL POINT OF PURCHASE FOR: SHIPPING DAMAGE, RETURNS, OR WARRANTY CLAIMS
- CONTACT DEE ZEE FOR MISSING PARTS OR HARDWARE

1-800-779-2102

Mon-Thurs: 8:00am - 5:00pm | Friday: 8:00am - 4:00pm (CST)

Scan to view instructions online:



INSTRUCTIONS ONLINE: www.deezee.com/instructions

INSTALLATION VIDEOS: www.deezee.com/tech-tips

PRODUCT REGISTRATION: www.deezee.com/registration

@DEEZEEMFG



www.deezee.com

⚠ WARNING: Cancer and Reproductive Harm
www.P65Warnings.ca.gov

Operating, servicing, and maintaining a passenger vehicle can expose you to chemicals such as lead, phthalates, engine exhaust, and carbon monoxide that are known to the State of California cause cancer and birth defects or other reproductive harm. To minimize exposure, service your vehicle and its accessories in a well-vented area and wear gloves or wash your hands frequently.



DEE ZEE, INC. WARRANTY AGREEMENT

Dee Zee, Inc. will manufacture the highest quality products for our customers through innovation, teamwork, and continuous improvement. Should the original purchaser experience manufacturer defects in materials or workmanship under normal use, Dee Zee, Inc. offers the below warranty coverage.

This warranty applies only to the original purchaser of new product(s) and is limited to the replacement of genuine Dee Zee products. Modification of any kind to Dee Zee products voids all warranty coverage. Warranty does not include electrical components, installation, cost of removal, labor, transportation costs, loss of use, inconvenience, or consequential damages.

Damage resulting outside of normal use such as road hazards such as gravel or other debris, product misuse, improper installation, impairments from accidents, product modifications, improper repairs, spills, vandalism, product neglect, lack of maintenance, not following cleaning instructions, or acts of God are not covered under this warranty agreement.

WARRANTY COVERAGE - MATERIALS & WORKMANSHIP

LIMITED LIFETIME WARRANTY:

- **STAINLESS STEEL:** Side Steps, Bull Bars, and Side Rails
- **ALUMINUM:** Side Steps, Running Boards, Storage Boxes, Transfer Tanks, Bed Protection, Side Rails, Platform Racks, Cargo Carriers, Cab Racks, Hex Series, and Invis-A-Rack
- **PLASTIC:** Storage Boxes

THREE-YEAR WARRANTY:

- **POWDER-COATED / E-COATED STEEL:** Side Steps, Running Boards, Storage Boxes, Transfer Tanks, Sport Bar, Ladder Racks, Universal Cargo Trays, Under Seat Storage Drawer, and Cargo Slides
- **MOUNTING BRACKETS:** purchased for installation (NX, 6", Rough Step, Louvered, Hex Series, Underbed Boxes, and Bumper Guards only)
- **OTHER:** Tailgate Assist, Bed Mats, Floor Mats, Mud Flaps, Tailgate Board, Hood Deletes, Fender Deletes, Hinge Covers, Door Pocket, Door Hangers, Auxiliary Fuel Connection Kits, Tie Down Anchors, and ALL products not otherwise listed individually

Warranty Coverage – Finish Protection

The finish of all Dee Zee products is covered for one-year (1) from the date of purchase. Dee Zee products have a high-quality finish that must be cared for and maintained like any other exposed finish on the vehicle. Protect the finish with non-abrasive automotive wax (e.g. Pure Carnauba) on a regular basis. Applying soaps, polishes, or waxes that contain an abrasive compound may scratch the finish and leave the exposed material susceptible to corrosion.

Warranty Coverage – Component Parts

Operational items such as shocks, latches, hinges, and other wear items including, but not limited to, mud flaps, step pads, toolbox tray, end caps, hardware, gaskets, seals, etc. have a one-year (1) warranty.

All replacement parts are non-returnable and non-refundable. Some replacement parts are available online at www.deezee.com/replacement-parts/ or they can be ordered via credit card by calling 1-800-779-2102.

Replacement keys are fulfilled by a third-party vendor and they can be ordered at www.easykeys.com/dee-zee. Locate the key code on the lock cylinder and use the drop-down menus. If you do not see your key code, enter the key code in the search bar. Dee Zee typically uses Eberhard lock cylinders if Dee Zee is not listed by name.

GPI® Fuel Pumps and Accessories

Great Plains Industries (GPI) products, including transfer tank pumps and fuel meters, are covered by the manufacturer's warranty policies. Dee Zee's warranty terms do not apply to GPI products. To submit a warranty claim, please contact GPI directly at 1-800-835-0113 or visit www.gpi.net.

Warranty Submission Procedure

All warranty claims will be initiated at the place of purchase. The original purchaser will be required to present the original sales receipt with purchase date shown and provide photographs of the defect. All warranty replacement requests must be submitted via email to returns@deezee.com.

In the event the originally purchased product style is no longer available, Dee Zee will warranty the defective part with a current equivalent. If a comparable product is no longer available, the product would be returned to the store of purchase for a refund or the applicable cost difference can be paid to choose an alternate style.

Disclaimers

All products are sold as appearance accessories and should not be relied upon as protection for the vehicle or its occupants in the event of an accident. Vehicles equipped with a supplemental restraints system (air bags) deployed by impact and collision avoidance systems should not be modified in any way. Always consult the vehicle manufacturer if you have any questions regarding supplemental restraint systems and sensors.

Buyer must accommodate front and rear sensors during product installation and assumes all risk should these be tampered, rerouted, severed, or disconnected. This includes disabling visual, audio, or vibration alerts into the cab. Buyer assumes all risk and responsibility for wiring any supplemental auxiliary lights.



Buyer assumes all risk, liability, and cost for the installation and use of Dee Zee products. Dee Zee, Inc. assumes no liability for injury, loss, incidental or consequential damages in the event of an accident.

California Proposition 65

WARNING: Operating, servicing, and maintaining a passenger vehicle can expose you to chemicals such as lead, phthalates, engine exhaust, and carbon monoxide that are known to the State of California cause cancer and birth defects or other reproductive harm. To minimize exposure, service your vehicle and its accessories in a well-vented area and wear gloves or wash your hands frequently. For more information visit: <https://www.p65warnings.ca.gov/>

Fender Delete Installation Instructions

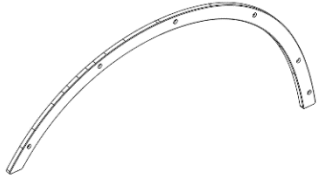
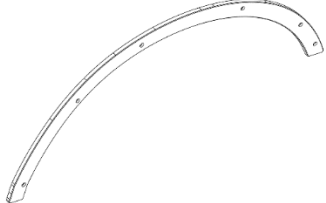
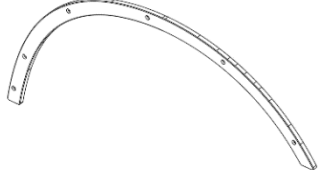
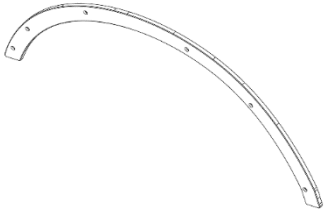
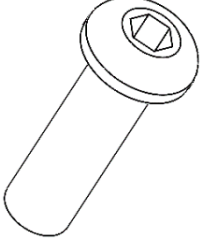
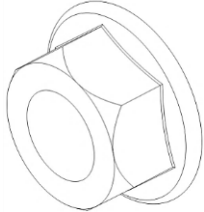
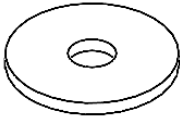
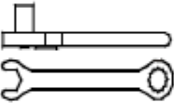
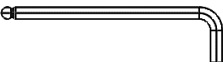
U725FD Ford Bronco 2021-Current

<p>A Front Driver Fender</p>  <p style="text-align: center;">U725 FDFD X1</p>	<p>B Rear Driver Fender</p>  <p style="text-align: center;">U725 RDFD X1</p>	<p>C Front Passenger Fender</p>  <p style="text-align: center;">U725 FPPD X1</p>
<p>D Rear Passenger Fender</p>  <p style="text-align: center;">U725 RPPD X1</p>	<p>E Button Head Bolt</p>  <p style="text-align: center;">PN 649B X24</p>	<p>F Serrated Flange Nut</p>  <p style="text-align: center;">PN 821 X18</p>
<p>G Washer</p>  <p style="text-align: center;">PN 265B X18</p>	<p>Required tools</p> <div style="display: flex; justify-content: space-around; align-items: flex-start;"> <div style="text-align: center;">  <p>10mm</p> </div> <div style="text-align: center;">  <p>Allen Wrench 4mm</p> </div> <div style="text-align: center;">  <p>Phillips Screwdriver</p> </div> </div>	

1 First locate and turn all the latches under the fenders so the handle is towards the center of the wheel.



2

Pull off fender by pulling straight out on the plastic fender.



Repeat Steps 1&2 on all four fenders.

3

Lay out the Fenders as shown below with the chamfered edge facing up. Use the angle cut edges and hole patterns to designate which fender is which.

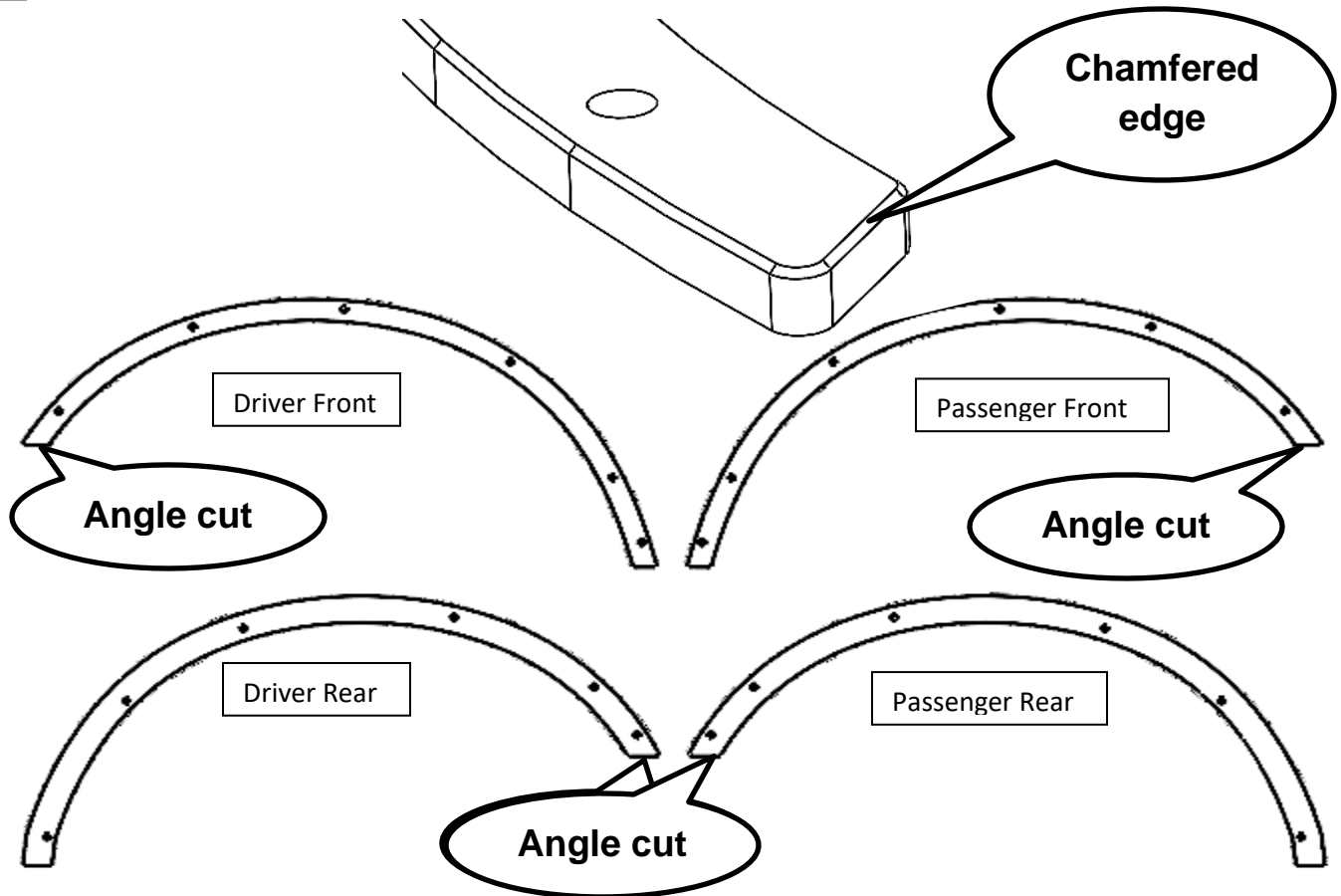

4 Install the proper fender by using Bolts (E), Washers (G), and Nuts (F) in the rectangle holes in the sheet metal of the vehicle.

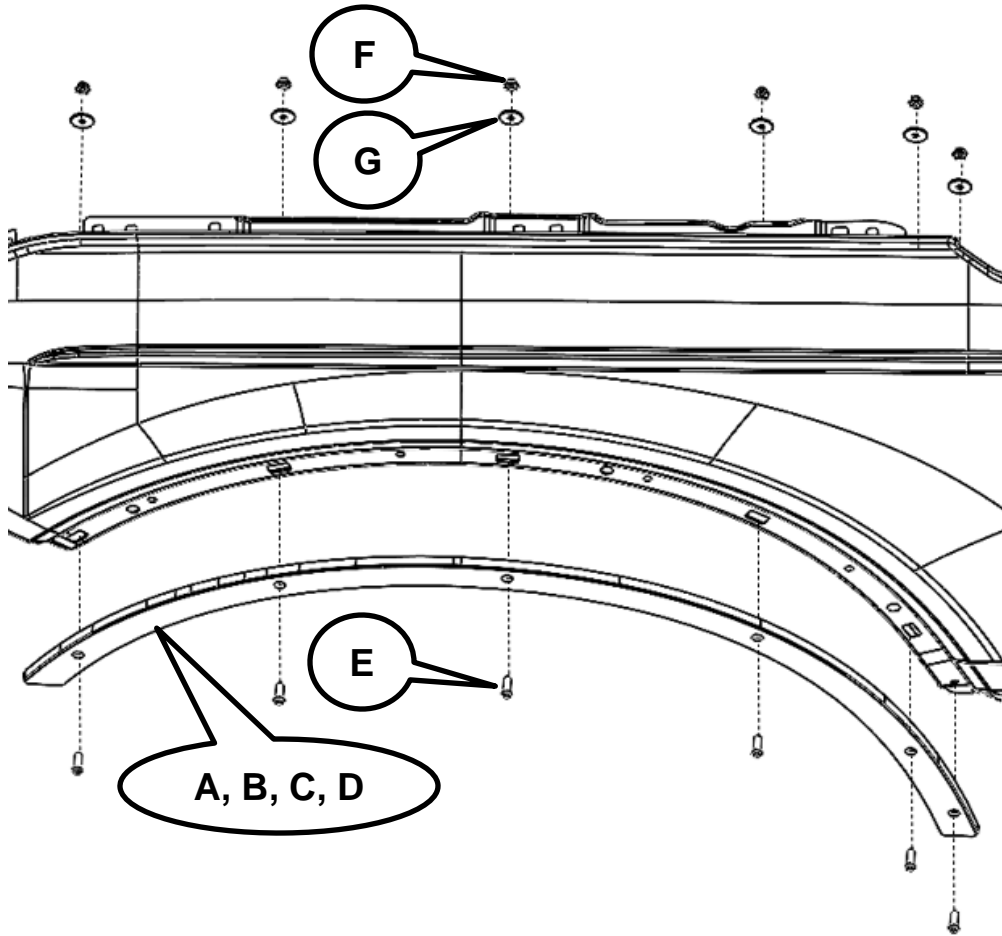

It will be necessary to remove the plastic screws from the felt fender well to access the back side of the fender to install washers (G) and nuts (F). Once fender delete (A, B, C, D) is installed, reinstall plastic screws to hold fender well in place.

